

Loading diagram

(150 bar)	12 volt	24 volt
Pump - Motor Unit	115 A	75 A
Magnet (hydraulic unit)	1,4 A	0,7 A
Magnet (electric safety valve)	1,5 A	0,75 A
Solenoid	1,8 A	0,9 A
Cable area:		
Control cable	1,5 mm ²	1,5 mm ²
Main cable 0-8m	35 mm ²	35 mm ²
Main cable 8-15m	35 mm ²	35 mm ²
Main cable <15m	-	35 mm ²
Power source:		
Min. capacity	140 Ah	110 Ah
Min. voltage	9 Volt	18 Volt

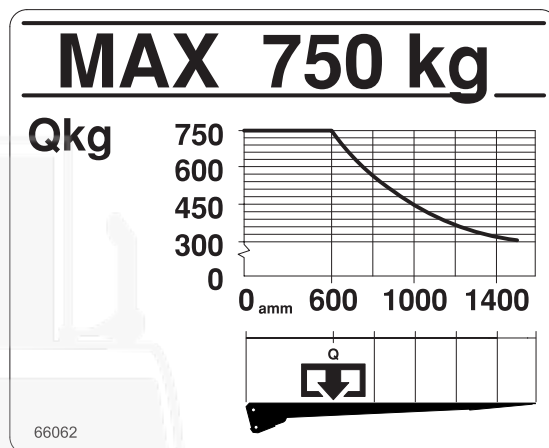

Installation dimensions (mm)

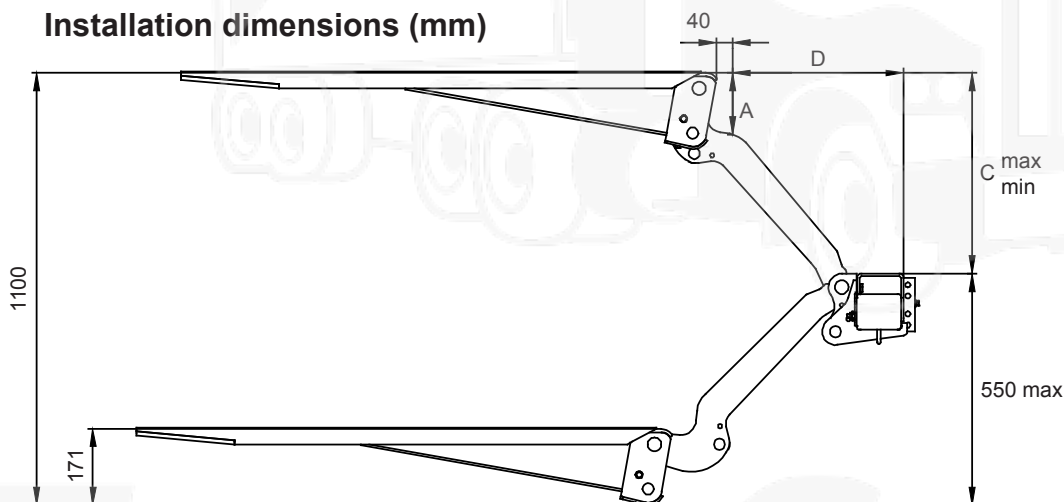

C	A	D
550	146	432
500	133	498
450	125	549
400	117	590
350	105	624
300	95	652
250	85	675

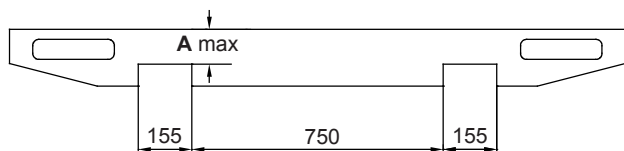
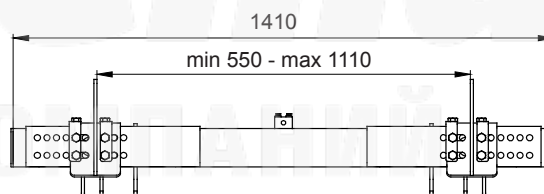
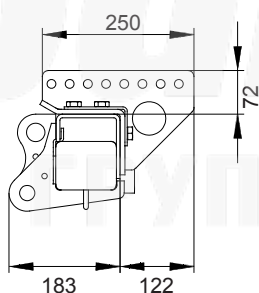

ZEPRO



Трак Стар
ГРУППА КОМПАНИЙ

Телефон: +7 927 503 2024

E-mail: ek225@truck-star.ru

Сайт: www.truck-star.ru